

Linea
Gesso

Gypsum Line

Squisci

Coving elements



Four Seasons Hotel - Firenze
Four Seasons Hotel - Florence



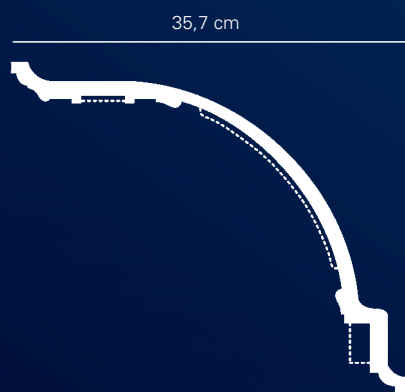
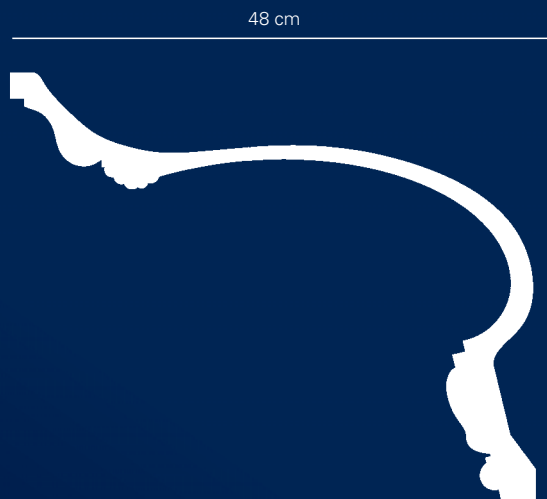

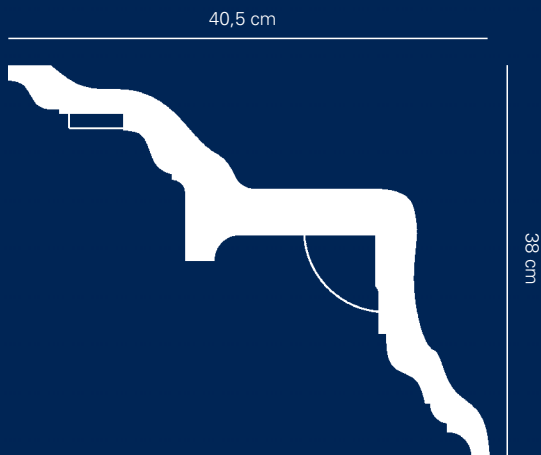

Art. 2168

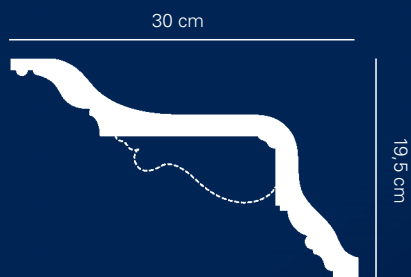

Art. 2277

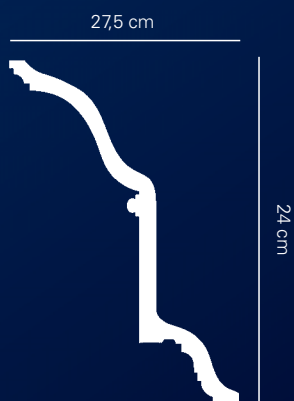

Art. 2200

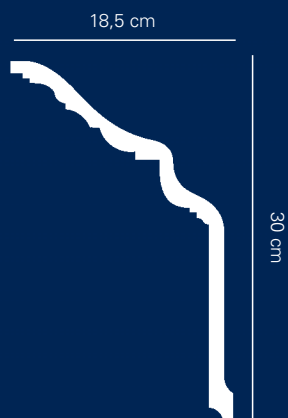

Art. 2282

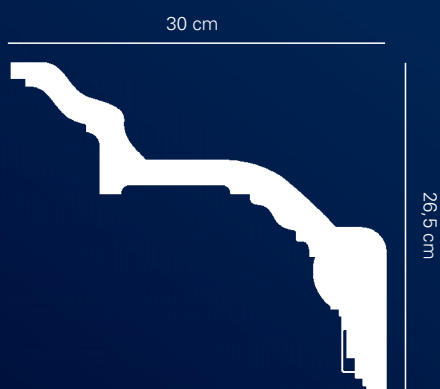

Art. 2101



Art. 2254

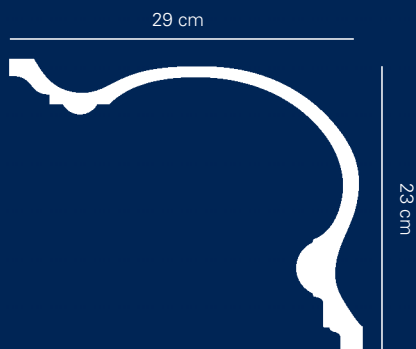

Art. 2223

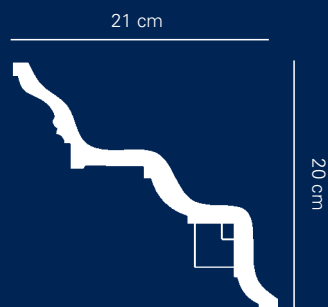

Art. 922



Art. 2267



Art. 2054

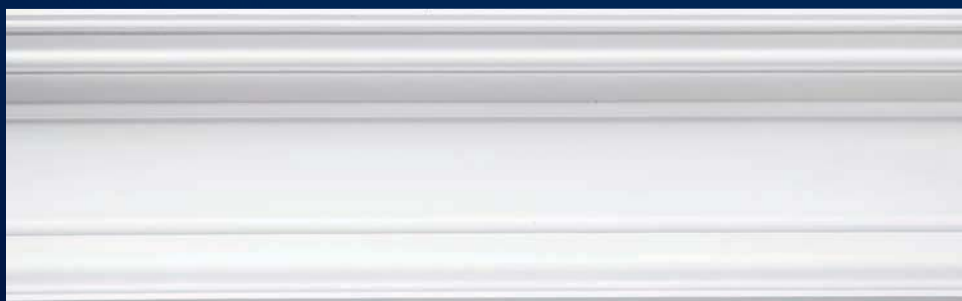
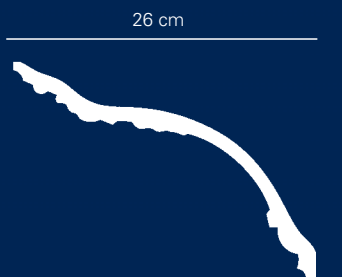



Art. 2126

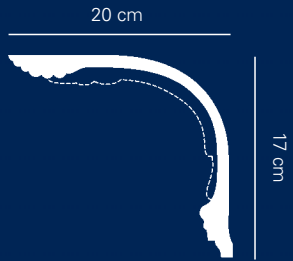

Art. 941

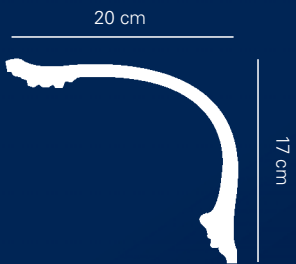

Art. 942

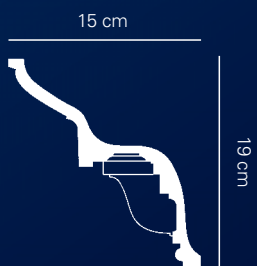

Art. 34/A

20 cm

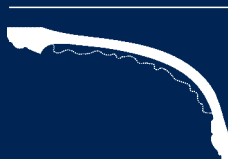

12 cm



Art. 31/A

21 cm

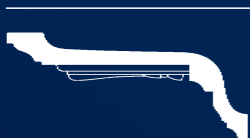

10 cm



Art. 2212

12 cm



14 cm



Art. 2151

11 cm



10 cm



Art. 33/A

8,5 cm



11 cm



Art. 630

9 cm



12,5 cm



Art. 929



Show room Color' Shop - Casapulla (CE)

Villa Privata - Yerevan Armenia
Private home



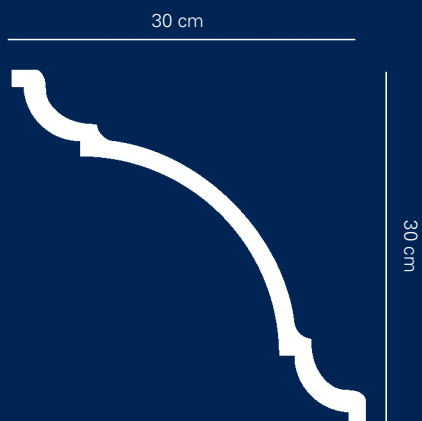

Art. 2259



Art. 186/B



Art. 2263



Art. 2182

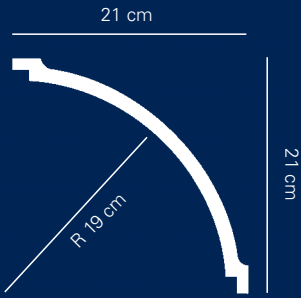

Art. 2013

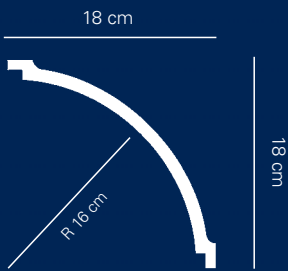

Art. 2147

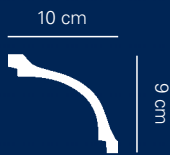

Art. 171

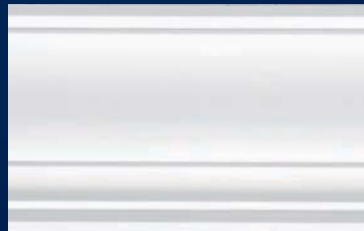
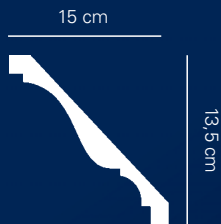

Art. 2206



Art. 927



Art. 2201



Art. 917



Art. 28/L



Art. 53/A

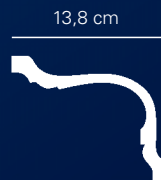

Art. 2150



Art. 906



Art. 2269



Art. 2246

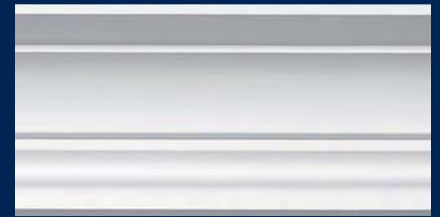

Art. 46/A



Art. 2202



Art. 2111



Art. 45/A



Art. 2102



Art. 2247



Art. 2232



Art. 2103



Art. 44/A



Art. 2207

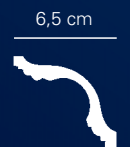

Art. 916



Art. 905



Art. 2066



Art. 2113



Four Seasons Hotel - Firenze - *Four Seasons Hotel - Florence*

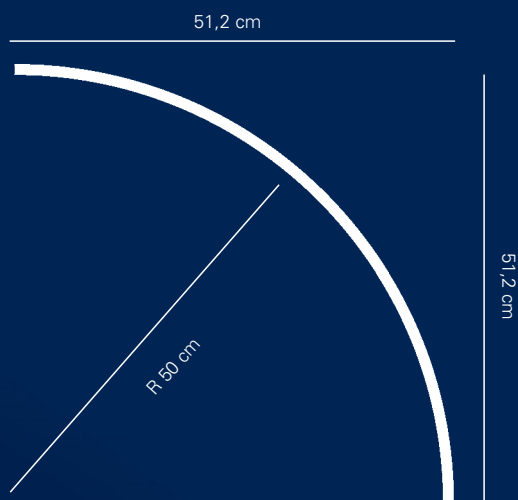

Art. 2237

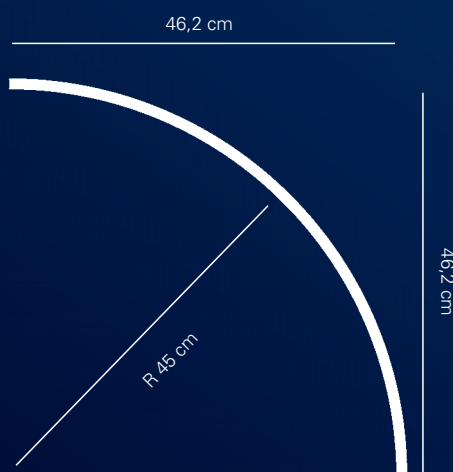

Art. 2236

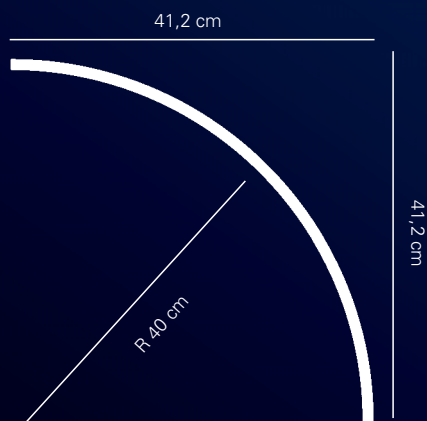

Art. 2225

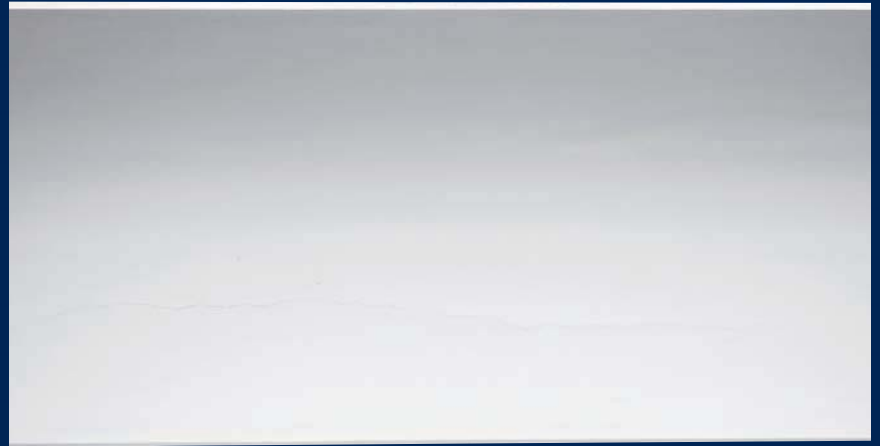
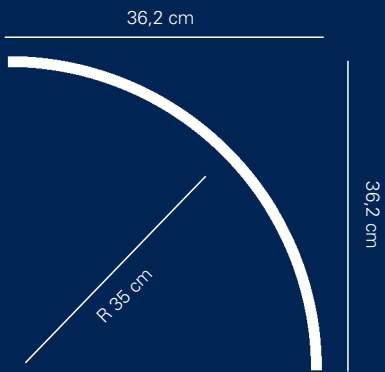

Art. 2226

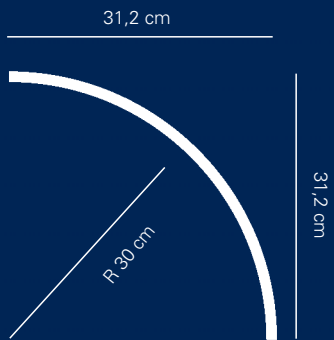

Art. 2227



Art. 2076

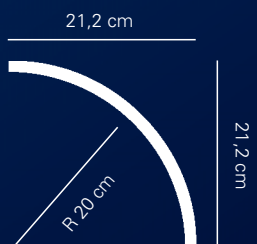

Art. 2075

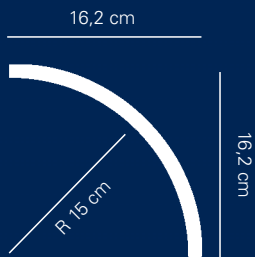

Art. 2064

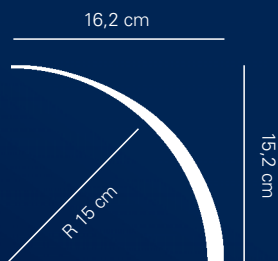

Art. 2064/Scomparsa
Effetto a scomparsa sul soffitto
Embossed effect on finished ceiling surface



Art. 2190

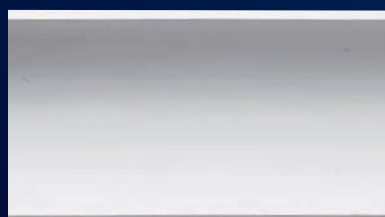

Art. 2077

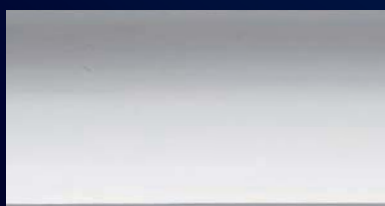
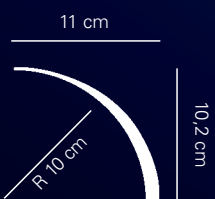

Art. 2077/Scomparsa
Effetto a scomparsa sul soffitto
Embossed effect on finished ceiling surface

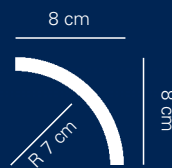

Art. 2170

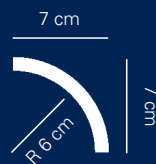

Art. 2199



Art. 2065

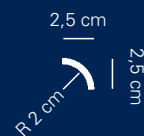

Art. 2178



Hotel Four Seasons - Firenze
Hotel Four Seasons - Florence



Hotel Cavalieri Hilton - Roma
Hotel Cavalieri Hilton - Rome

Ristorante da Iva - Bucchianico (CH)



Linea
Gesso

Gypsum Line

Cornici

Frames



Villa Privata - Yerevan Armenia
Private home

Hotel Four Seasons - Firenze
Hotel Four Seasons - Florence



4,7 cm



28,7 cm



Art. 2180

6,7 cm



24,5 cm



Art. 34/B

6,5 cm



23,5 cm



Art. 2127

5,5 cm



23,5 cm



Art. 903

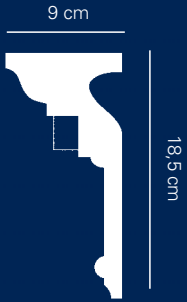

Art. 2209



Art. 34/C



Art. 173



Art. 2175



Art. 2181



Art. 618



Art. 604



Art. 617



Art. 2120



Art. 199

5,3 cm



34,5 cm



Art. 2155

16 cm



25,5 cm



Art. 2139

7,5 cm



21,8 cm



Art. 2049

7 cm



30 cm



Art. 2261

8,3 cm



16 cm



Art. 2062

6,5 cm



19,5 cm



Art. 2262

15 cm



15 cm

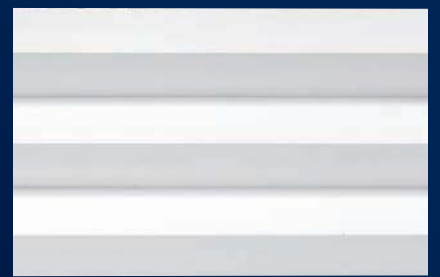

Art. 2088

6,5 cm



19 cm



Art. 2253

9 cm



9 cm

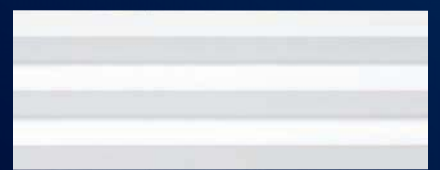

Art. 2087



Profili per spigoli

Corner profiles

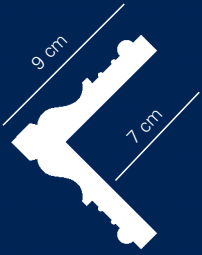

Art. 936



Art. 2042



Art. 2134



Art. 943



Art. 2144



Art. 2161

La linea ed il profilo di questi articoli sono particolarmente adatti per la realizzazione di porte e finestre per ambienti sia interni che esterni; in questo caso, su richiesta, possiamo produrli in materiale specifico idrorepellente.

The lines and profiles of these articles are especially suited for doors and windows for both interiors and exteriors; on request, we can supply articles for exteriors in specific water-repellent material.

2,3 cm



16,2 cm

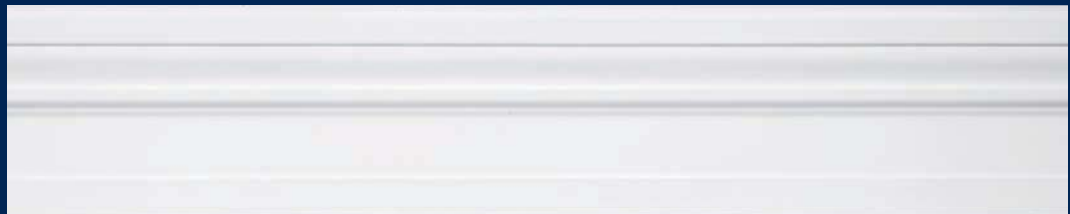

Art. 2235

3,8 cm



15 cm



Art. 925

4 cm



11,5 cm



Art. 2159

3 cm



11 cm



Art. 2169

3 cm



9,3 cm



Art. 2137

1,5 cm



5,8 cm

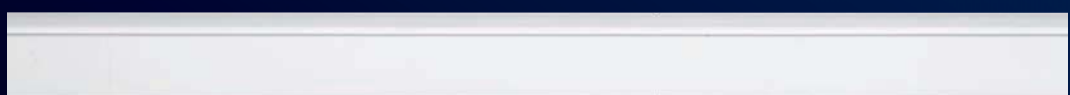

Art. 2130



Questi prodotti si producono su richiesta anche in gessi speciali particolarmente resistenti per l'utilizzo come battiscopa

These products are available on order in special high-strength plasters for use as skirting boards.

1,5 cm



24,5 cm

4 cm

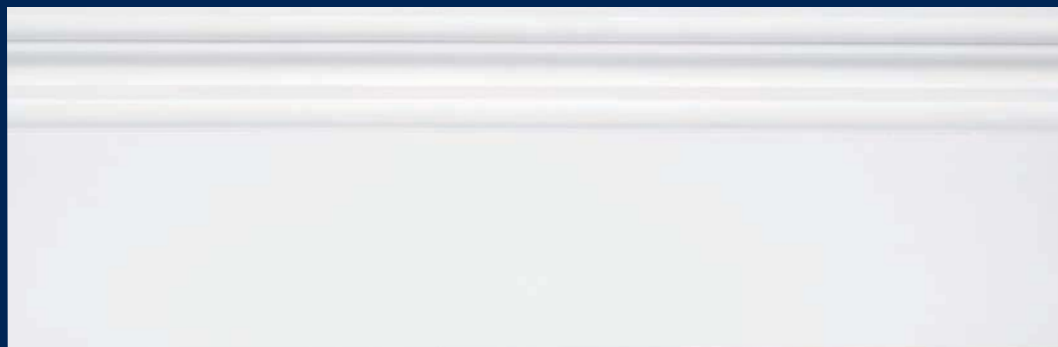

Art. 2153

1,5 cm



19,5 cm

2,7 cm

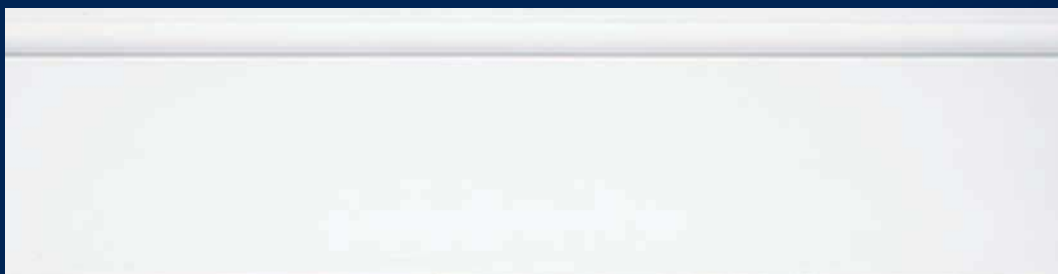

Art. 2167

0,8 cm



16 cm

2 cm

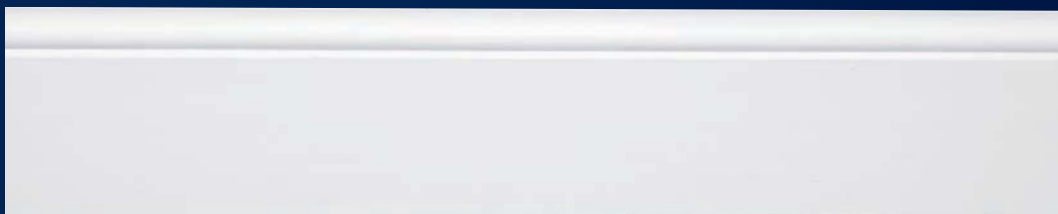

Art. 2093

0,8 cm



13 cm

2 cm



Art. 2198

1,8 cm



12,5 cm

3,5 cm



Art. 2214



Art. 2050



Art. 2183



Art. 2274



Art. 907



Art. 138



Art. 2104



Art. 912



Art. 52/A



Art. 28/B



Art. 920



Art. 155



Art. 50/A



Art. 2012



Art. 633



Art. 651/B



Art. 632



Art. 146



Art. 144



Art. 150



Art. 177



Art. 194



Art. 2171



Art. 2270



Art. 153



Art. 156



Art. 102



Art. 163



Art. 613



Art. 165



Art. 103



Art. 2124



Art. 2123



Art. 647/B



Art. 161



Art. 2074



Art. 195



Art. 123



Art. 196



Art. 601



Art. 119



Art. 159



Art. 622



Art. 121



Art. 49/A



Art. 2265



Art. 160



Art. 2008



Art. 104



Art. 935



Art. 179



Art. 140



Art. 164



Art. 2007



Art. 122



Art. 616



Art. 2264



Art. 2086



Art. 2157

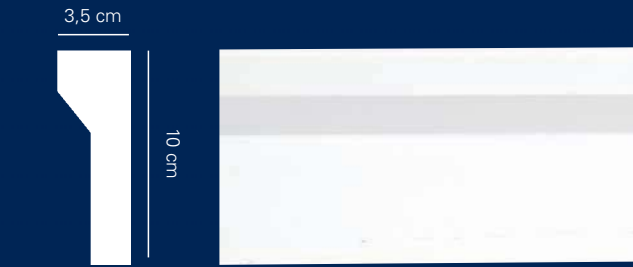

Art. 2204



Art. 2203



Art. 2276



Art. 2006



Art. 2248



Art. 43/A



Art. 2118



Art. 48/A



Art. 609



Art. 191



Art. 2249



Art. 2173



Art. 109



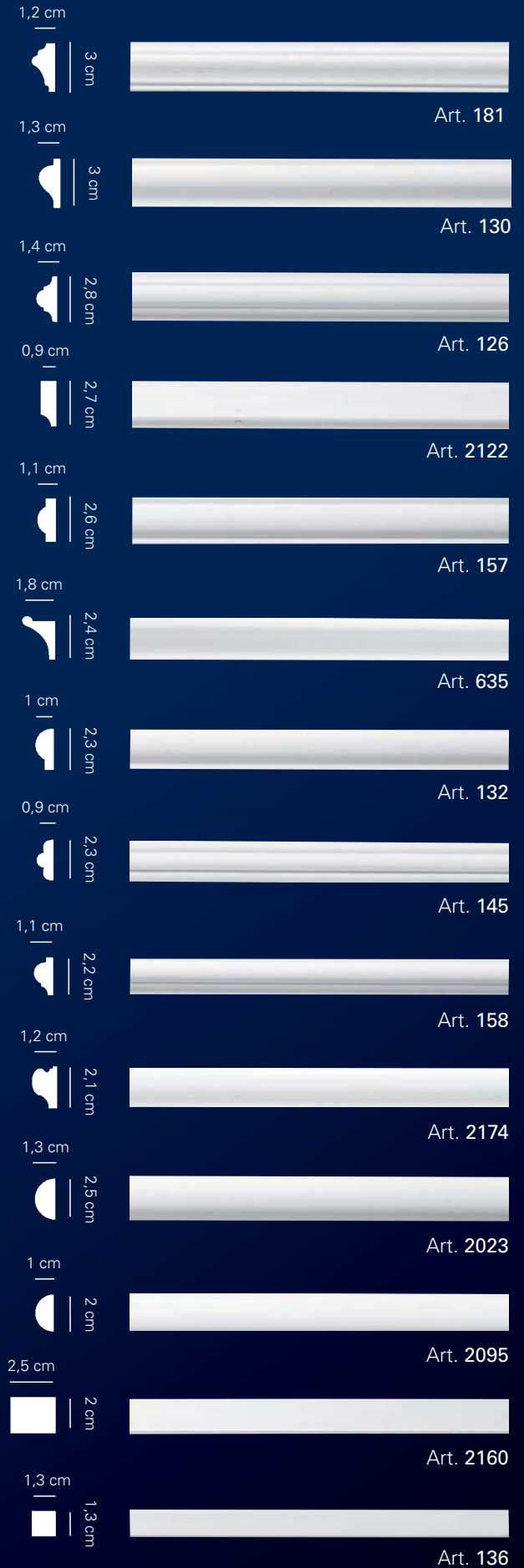
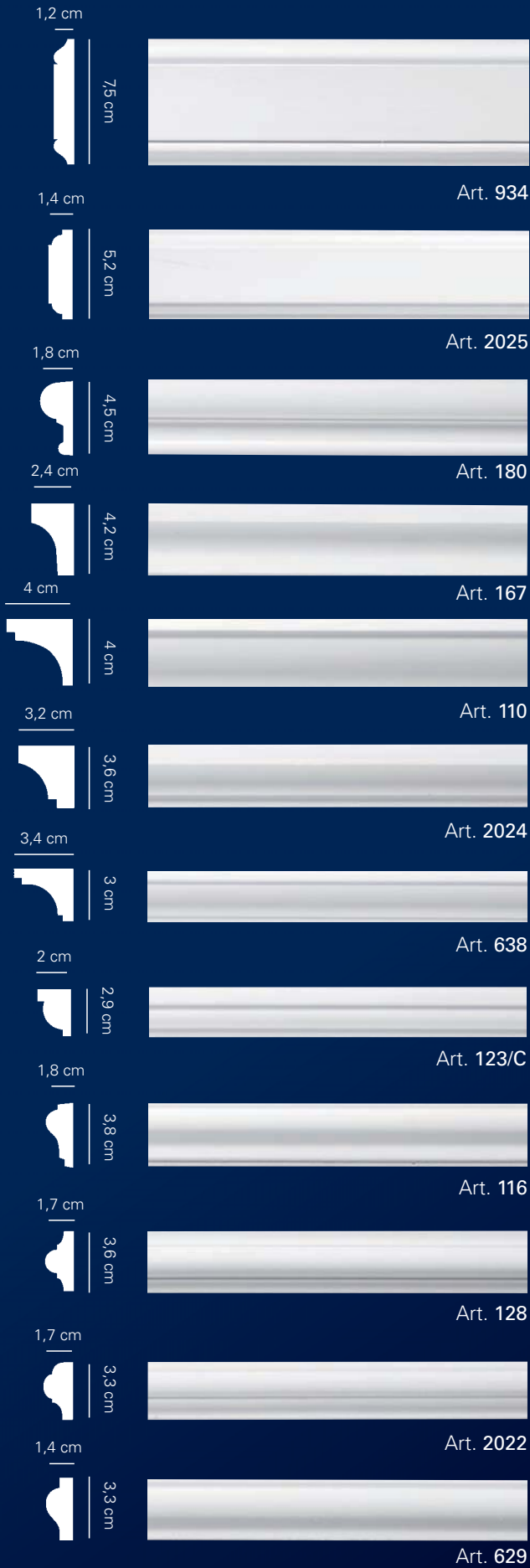

Questi articoli sono realizzati con materiali specifici ed una tecnica particolare per ottenere un effetto a scomparsa.
 These articles are manufactured in specific materials and by a special technique to obtain an embossed effect on the finished the ceiling surface.

1 cm
L 174 cm



Art. 2222



Esempio di realizzazione Art. 2222
 Example of installation

1 cm
L 150 cm



Art. 2219

0,8 cm
L 150 cm



Art. 2218

Pannelli a scomparsa / Embossed-effect Panels



Art. 1655
 146,5 x 20,5 cm



Art. 1656
 134 x 20,5 cm

0,8 cm



34,5 cm

Art. 1646



Hotel Armonia - Pontedera (PI)

Gelateria Acropolis - Colle di Val D'Elsa (SI)
Acropolis ice-cream parlour - Colle di Val D'Elsa (SI)



Linea
Gesso

Gypsum Line

*Luci
Diffuse*

Lighting covers



Show room Color' Shop - Casapulla (CE)

Abitazione Maurizio Fiori - Certaldo (FI)
Maurizio Fiori's house - Certaldo (FI)





Art. 2135

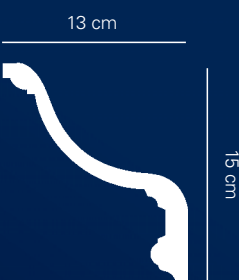

Art. 2131



Art. 2092



Art. 2014

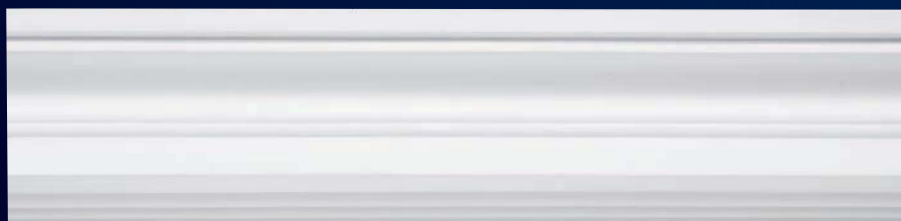
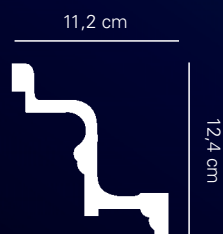

Art. 170



Art. 2040

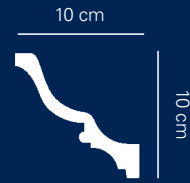

Art. 2027

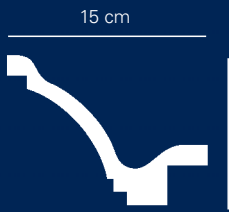

Art. 2096



Art. 2080



Art. 111



Art. 2039



Art. 2015



Art. 626

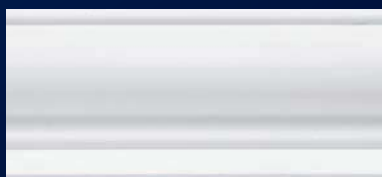

Art. 2082

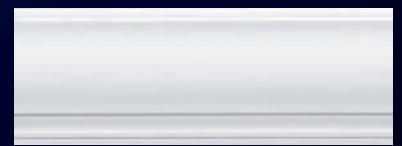

Art. 2091